

Varenummer: 2032100M850A1S
 Beskrivelse: E+G Justerfod
 GN 32-100-M8-50-A1-S
 Note: S Uden møtrik, udvendig sekskant i bunden

Mål

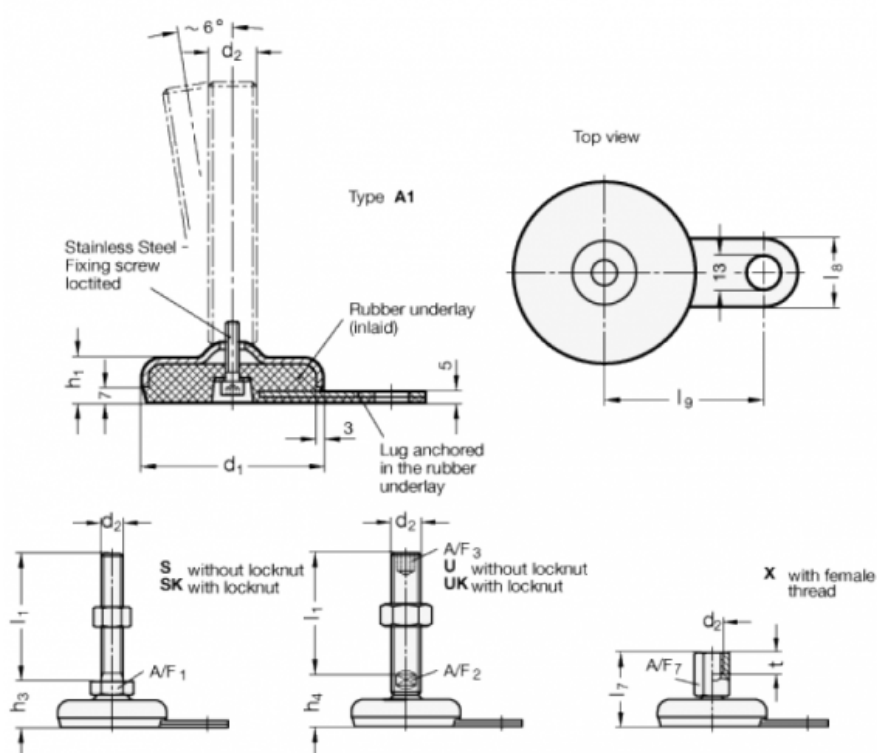

| | |
|------|-------|
| A/F1 | = 17 |
| d1 | = 100 |
| d2 | = M8 |
| h1 | = 21 |
| h3 | = 29 |
| l1 | = 50 |
| l8 | = 30 |
| l9 | = 80 |